

Instituto de Química de São Carlos
Universidade de São Paulo

Espectrometria no Infravermelho (FTIR):

diferentes técnicas para avaliação espectral do
ácido benzoico

Disciplina: Análise Instrumental I

SQM0415

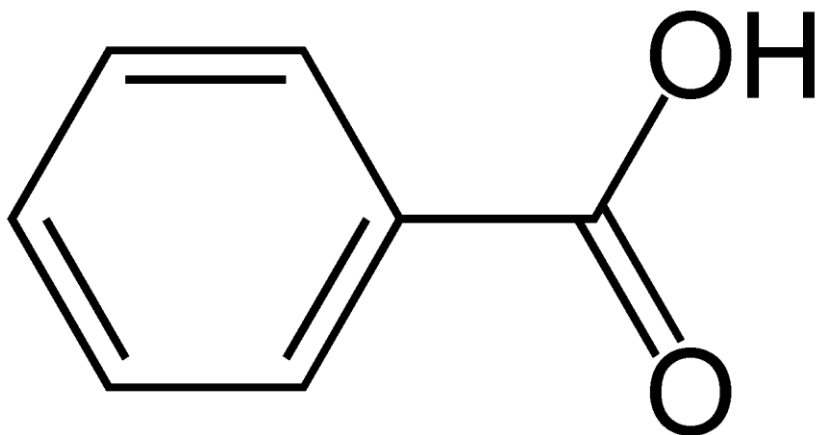

Ácido benzoico:

Usado como conservante em bebidas e alimentos.



Fontes:

<http://4.bp.blogspot.com/-VIQmuK4C7rs/TjFLjQBbaMI/AAAAAAAAA-c/6Ks803vjrVc/s320/2.jpg>

http://upload.wikimedia.org/wikipedia/commons/1/18/Benzoid_acid.jpg

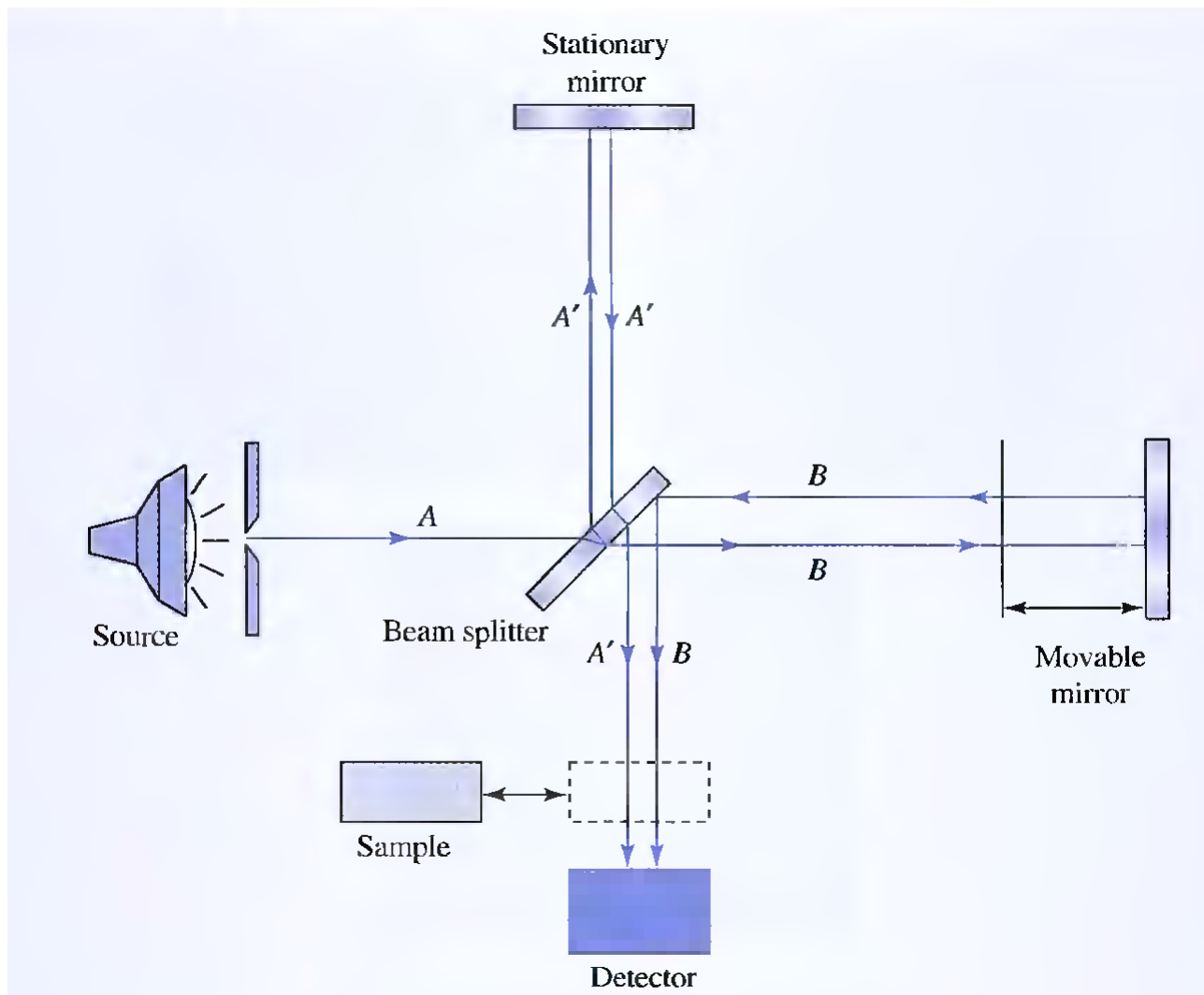

Fonte: SKOOG, D.A.; et al. Fundamentals of Analytical Chemistry, 8 ed.

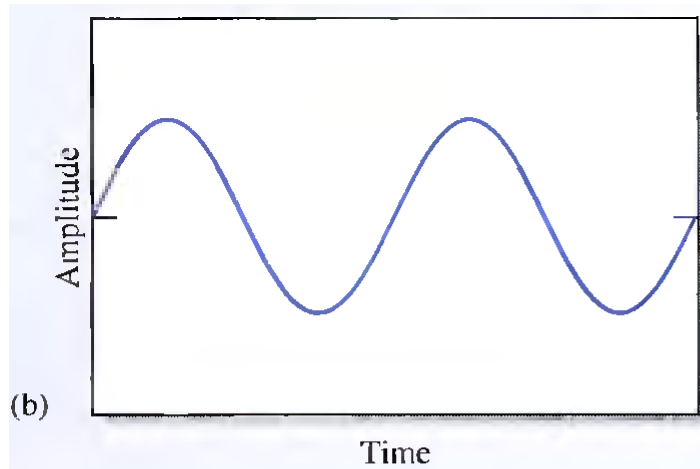

Fourier transform

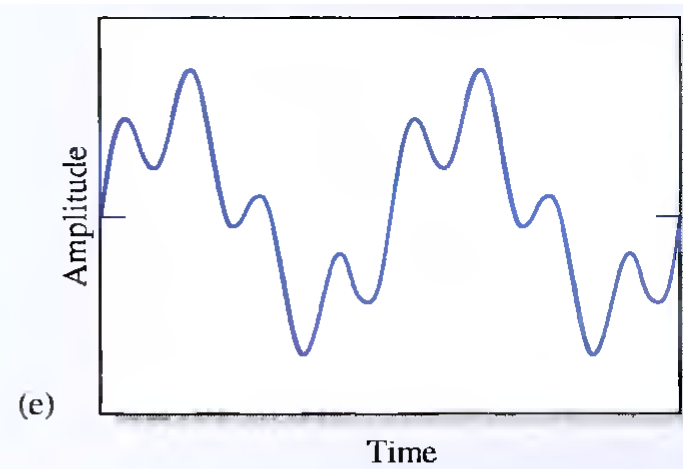
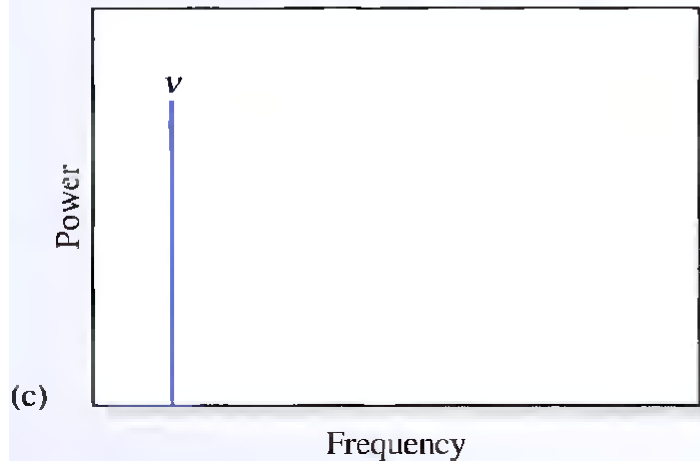

Fourier transform

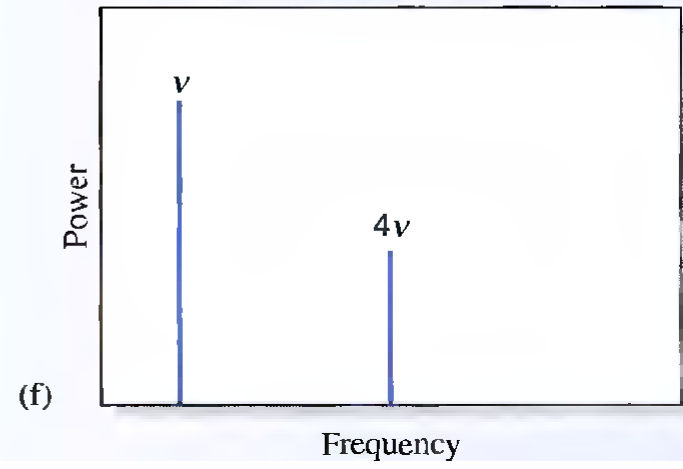

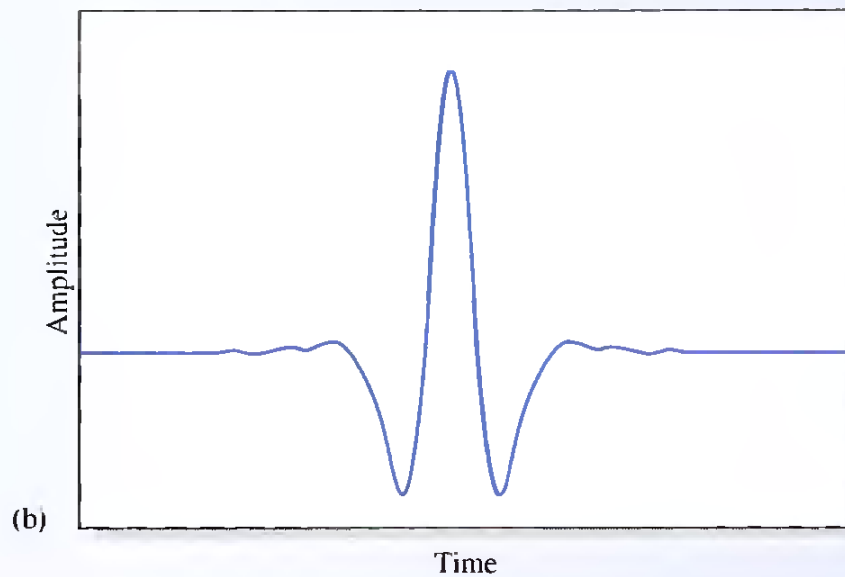
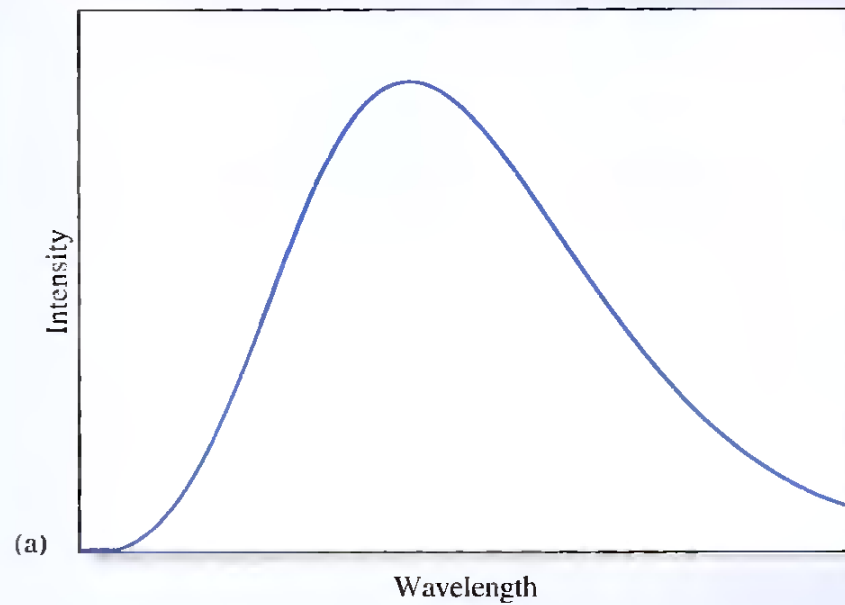
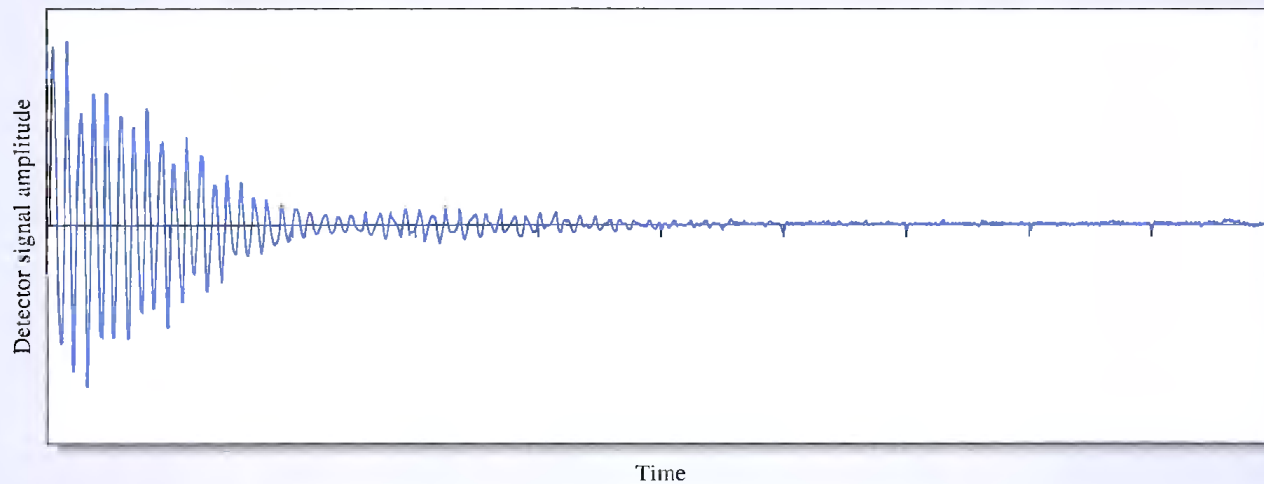
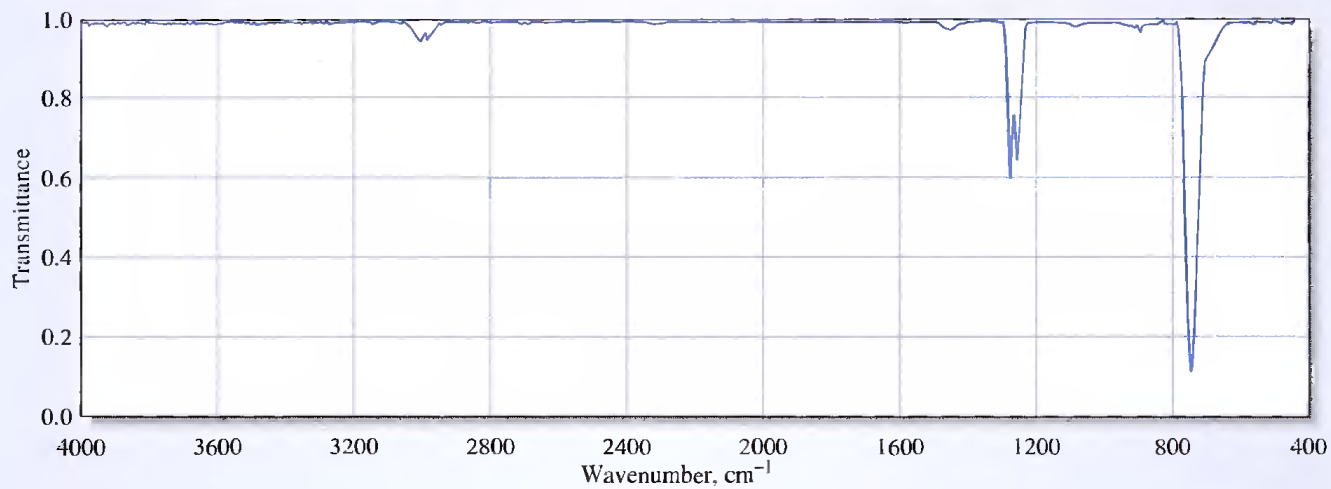

Figure 25F-9 (a) Spectrum of a continuum light source. (b) Interferogram of the light source in (a) produced at the output of the Michelson interferometer.



(a)



(b)

FT-IR Spectroscopy

Attenuated Total Reflectance (ATR)

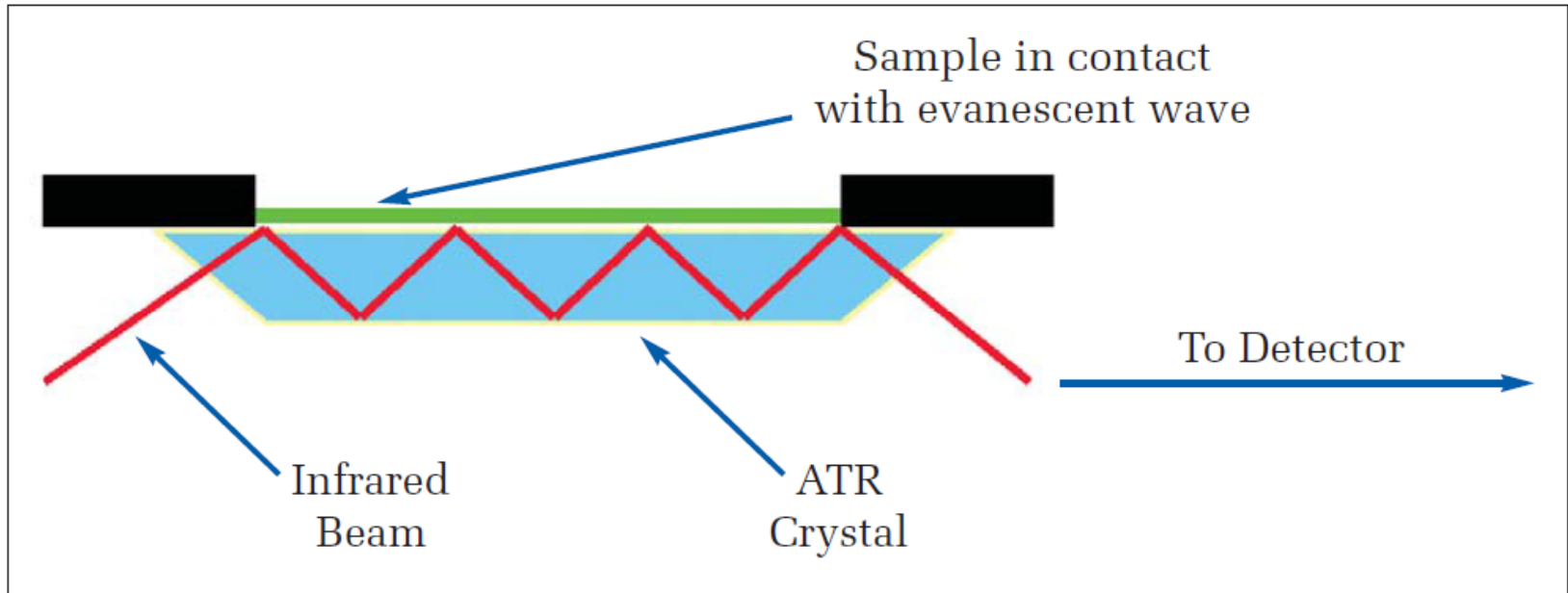

Outras técnicas para análise e preparo da amostra

- Absorção no IV e Espalhamento Raman
- Pastilhas de KBr, filme de Nujol

Instituto de Química de São Carlos
Universidade de São Paulo

Fluorescência de Raio-X (XRF): análise de ligas metálicas em moedas brasileiras

Disciplina: Análise Instrumental I
SQM0415

Moedas brasileiras de diferentes décadas

									
1908	1923	1930	1940	1956	1961	1970	1981	1993	2005

Industry solutions

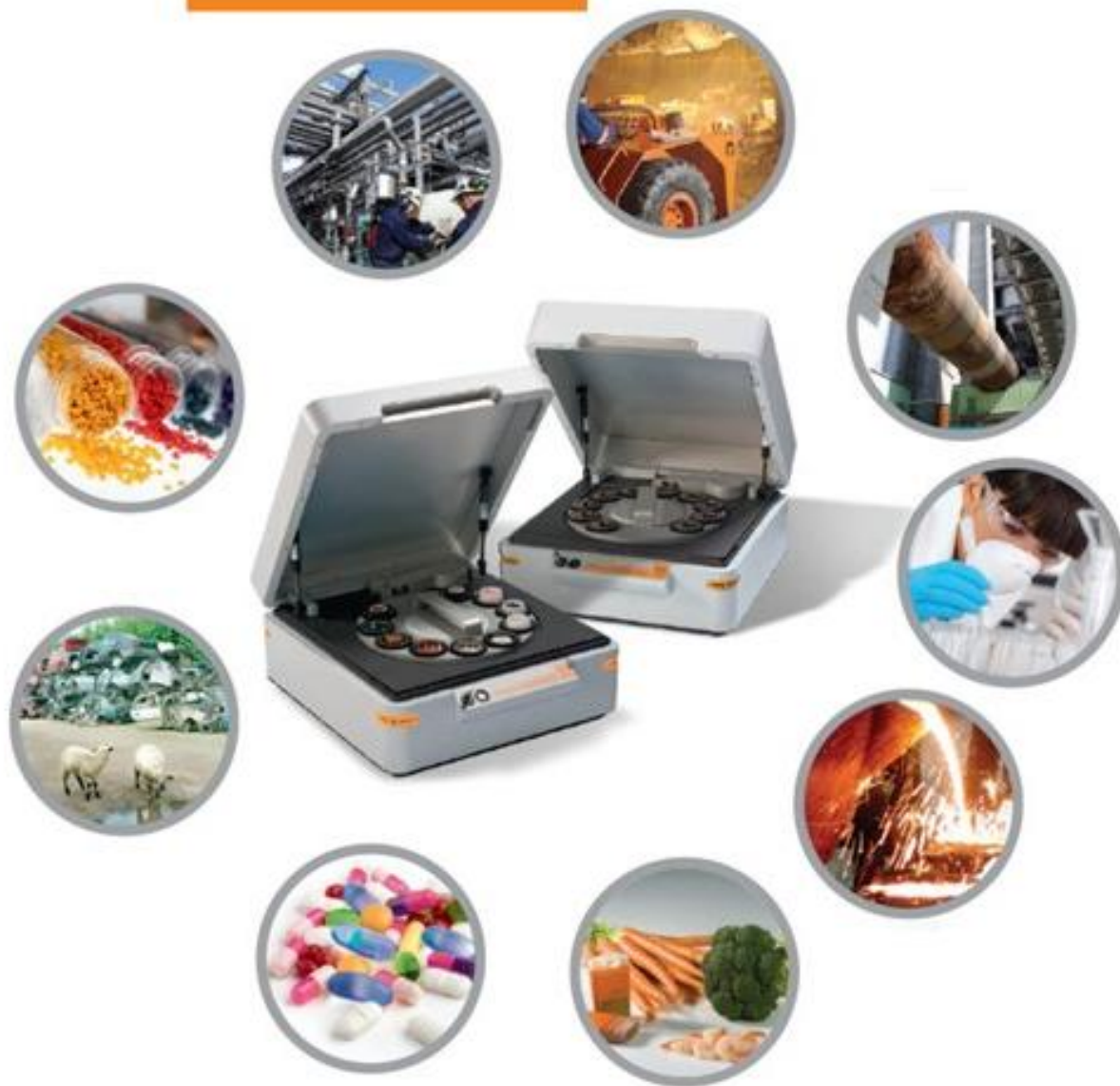

Fonte: PANanalytical, Epsilon 3^x spectrometers, PN9286.pdf

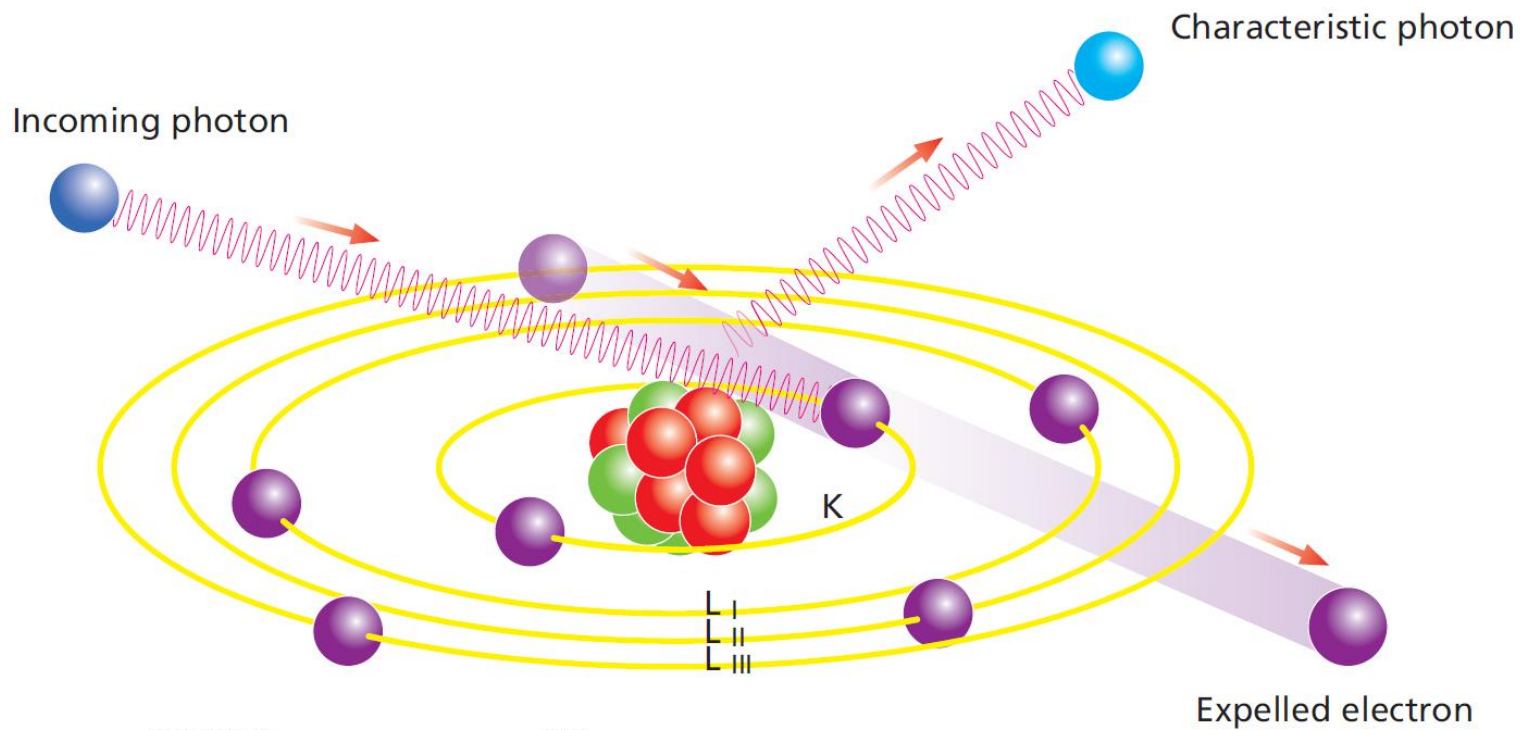

Figure 4. Production of characteristic radiation

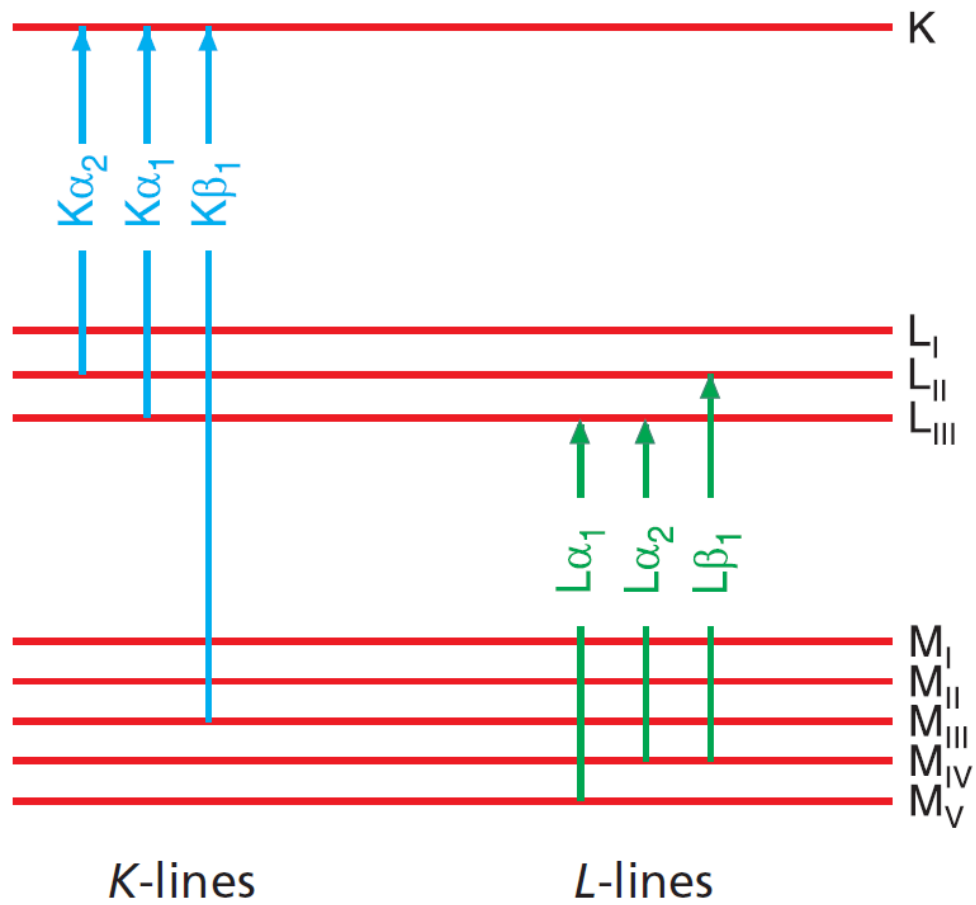
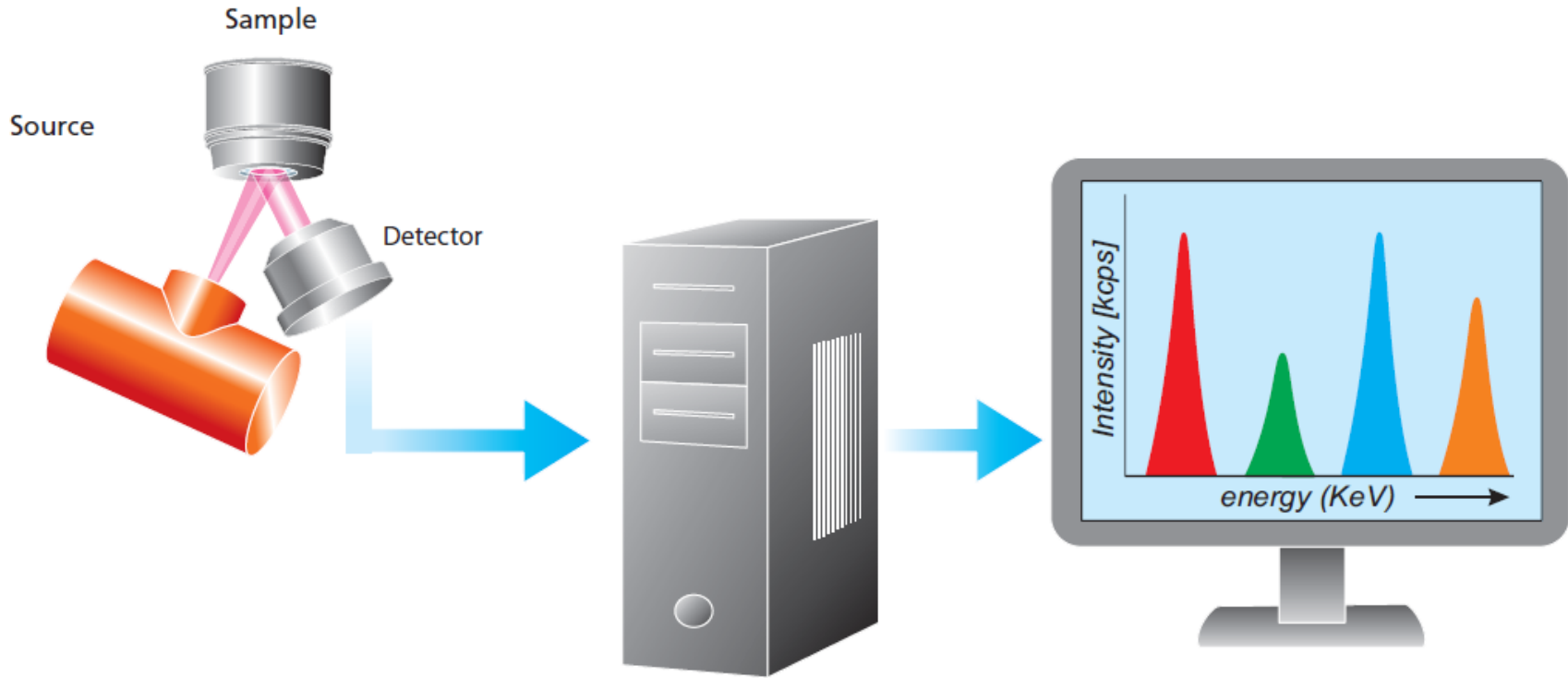

Figure 7. Major lines and their transitions

EDXRF



Fonte: Peter Brouer, Theory of XRF, PANanalytical

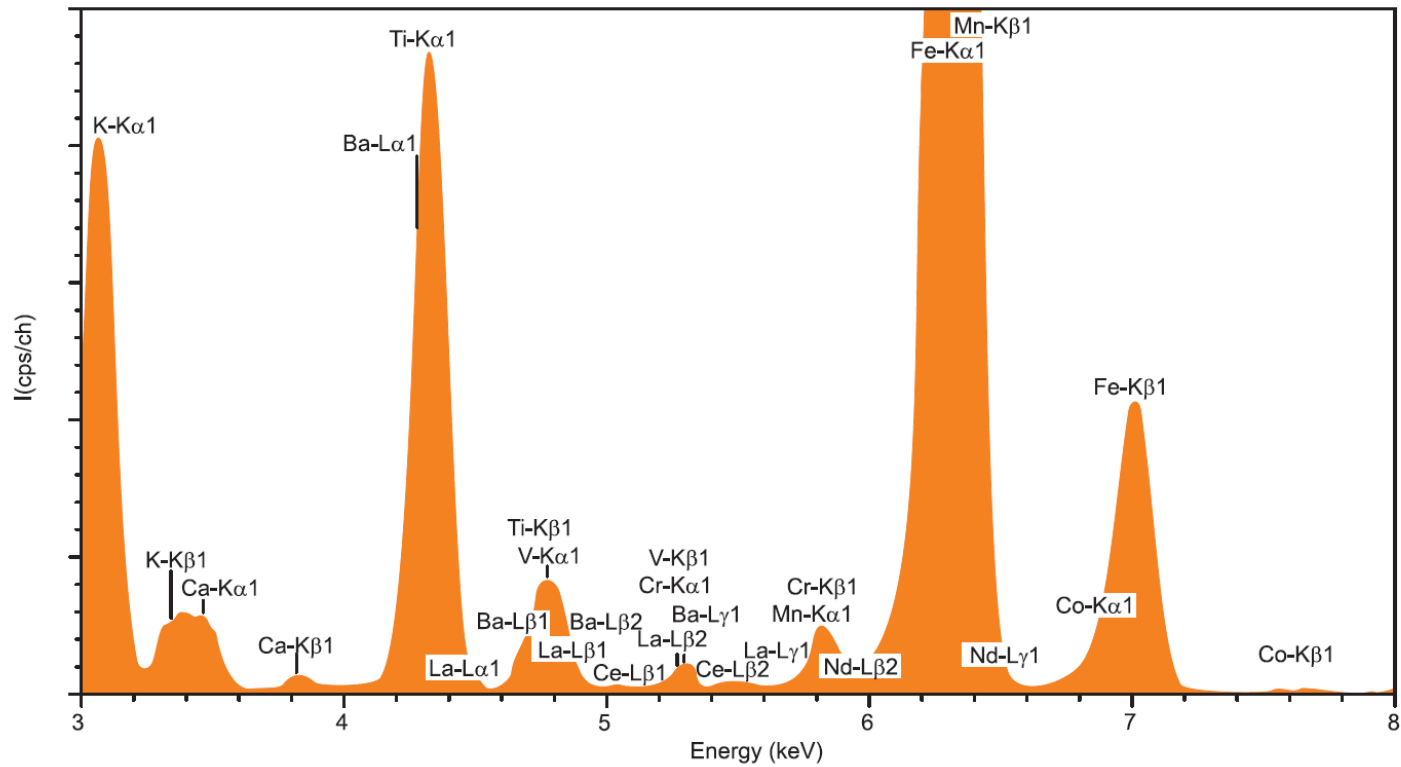

Figure 20. Typical spectrum of a soil sample measured with an EDXRF spectrometer having 3D optics and indirect excitation

Some of the advantages and disadvantages of EDXRF and WDXRF spectrometers are summarized in Table 2.

	EDXRF	WDXRF
Elemental range	Na .. U (sodium .. uranium)	Be .. U (beryllium .. uranium)
Detection limit	Less optimal for light elements Good for heavy elements	Good for Be and all heavier elements
Sensitivity	Less optimal for light elements Good for heavy elements	Reasonable for light elements Good for heavy elements
Resolution	Less optimal for light elements Good for heavy elements	Good for light elements Less optimal for heavy elements
Costs	Relatively inexpensive	Relatively expensive
Power consumption	5 .. 1000 W	200 .. 4000 W
Measurement	Simultaneous	Sequential/simultaneous
Critical moving parts	No	Crystal, goniometer

Table 2. Comparison of EDXRF and WDXRF spectrometers